

[Standard] Dovetail Rack & Pinion Type

Z-Axis Standard / Z-Axis Long

Travel per Rotation	Small	Medium	Large
Stroke	Short	Medium	Long
Load Capacity	Light	Medium	Heavy

Z-Axis Standard

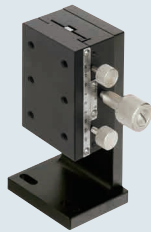

RoHS10

ZDTS50

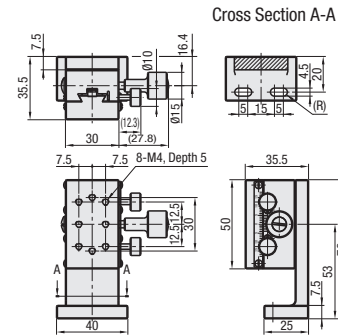

ZDTS60

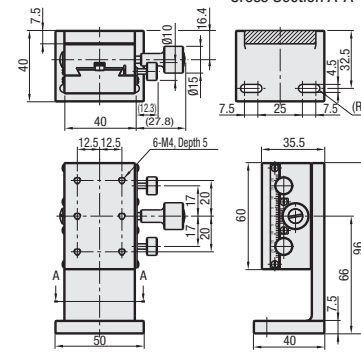

ZDTS90

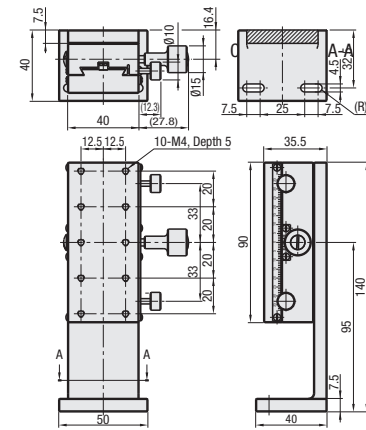

Material: Aluminum Alloy
Surface Treatment: Black Anodize

Z-Axis Stages High Precision Stage Product: ZWG P.2060

Part Number	Stage Surface	Travel Distance	Travel Per Knob Rotation	Load Capacity	Travel Accuracy	Weight
Type	A	(mm)	(mm)	(N)	Straightness	(kg)
ZDTS	50	30 x 50	±16	16.7	50 μm	0.26
	60	40 x 60	±21			
	90	40 x 90	±35			

Resolution (Vernier Scale Indication): 0.1 mm/division

Knob Cover HDCVR15 (Sold Separately): Ø15 knobs can be increased in diameter by installing the cover. P.2011



Part Number Example

Part Number ZDTS90

Z-Axis Long



RoHS10

ZDTLS80

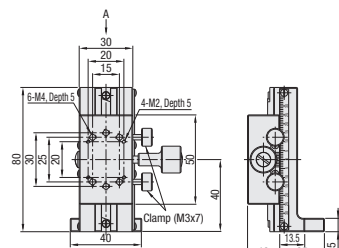

Arrow View A

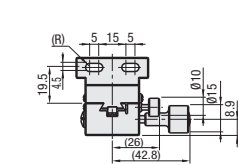

ZDTLS100

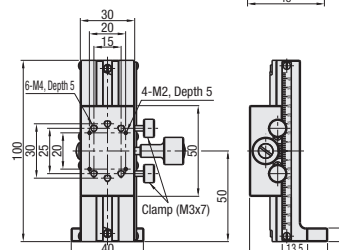

ZDTLS150

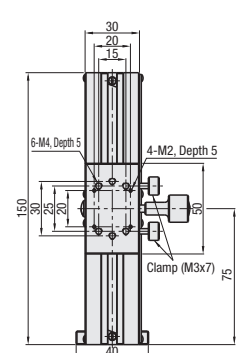

Material: Aluminum Alloy
Surface Treatment: Black Anodize

Z-Axis Stage High Precision Stage Product: ZLWG P.2062

Part Number	Stage	Travel Distance	Travel per Rotation	Load Capacity	Travel Accuracy	Weight
Type	No.	(mm)	(mm)	(N)	Straightness	(kg)
ZDTLS	80	30 x 50	±30	16.7	50 μm	0.16
	100		±40			
	150		±65			

Min. Reading (Vernier Scale Indication) : 0.1 mm/division

Knob cover HDCVR15 (Sold separately): Increases knob diameter by attaching to the Ø15 adjustment screw. P.2011



Part Number Example

Part Number ZDTLS100

[Standard] Dovetail Rack & Pinion Type

Z-Axis Low Profile

Travel per Rotation	Small	Medium	Large
Stroke	Short	Medium	Long
Load Capacity	Light	Medium	Heavy

Z-Axis Low Profile



RoHS10

Actual products may differ from the photos. See CAD data for the details.

ZDZSC50

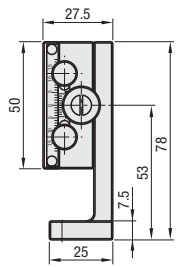
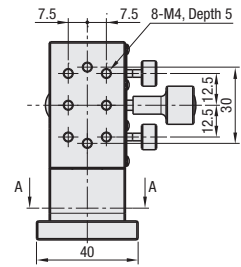
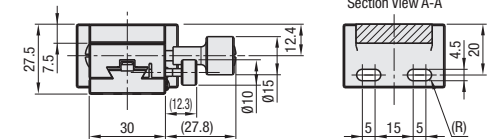

ZDZSC60

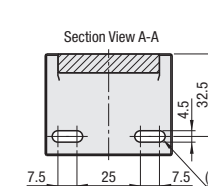
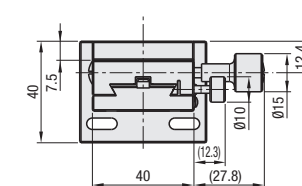

ZDZSC90

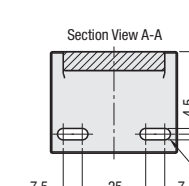
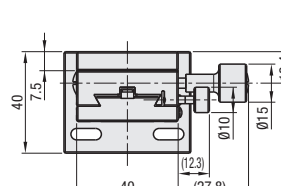

Material: Aluminum Alloy
Surface Treatment: Black Anodize

Z-Axis Stages

Part Number	Stage Surface	Travel Distance	Travel per Knob Rotation	Load Capacity	Travel Accuracy	Weight
Type	A	(mm)	(mm)	(N)	Straightness	(kg)
ZDZSC	50	50 x 30	±15	16.7	50 μm	0.23
	60	60 x 40	±20			0.33
	90	90 x 40	±35			0.43

Resolution (Vernier Scale Indication): 0.1 mm/division

Knob Cover HDCVR15 (Sold Separately): Ø15 knobs of Dovetail Stages can be increased in diameter by installing the cover. P.2011

Standard Type: ZDTS P.2014



Part Number Example

Part Number ZDZSC60