

Flat Belt Conveyor Full Belt Type

End Drive, 2-Groove Frame (Pulley Dia. 30mm)

CE Compliant

Features: Conveyor with full width belt that the entire surface can be used for transporting.

Flat Belt Conveyor Full Belt Type – End Drive, 2-Groove Frame (Pulley Dia. 30mm)

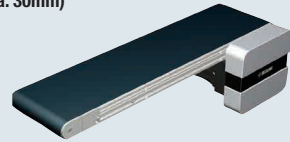

	Frame	Motor Cover	Pulley Holder (1)	Pulley Holder (2)
Material	Aluminum	Aluminum	5052 Aluminum Alloy	1018 Carbon Steel
Surface Treatment	Clear Anodize	Paint	Clear Anodize	Trivalent Chromate

Frame Cross Section and Enlarged View (Symmetrical)

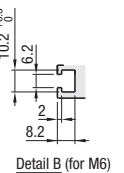
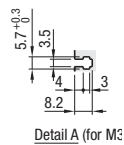
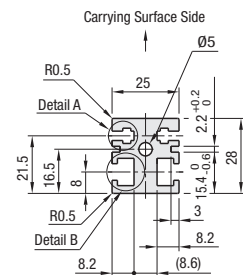

Compatible with JIS standard hex nuts.

CVSFA 6W Motor Type

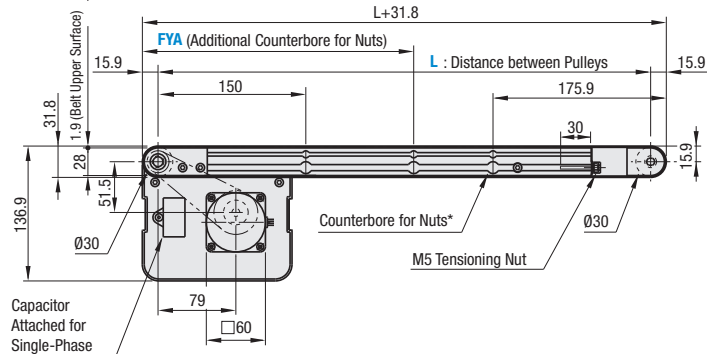
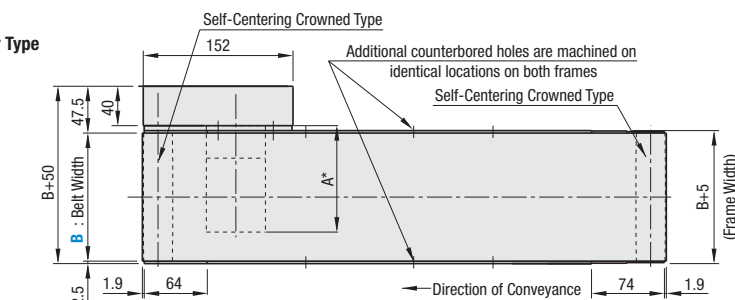

25W Motor Type

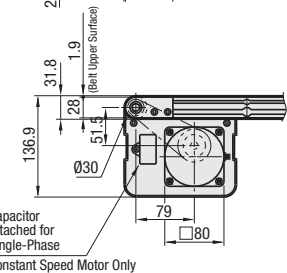
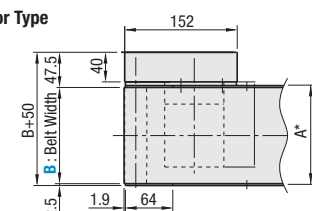

*When $L \leq 360$, counterbores for the nuts will not be provided. However, each slot has 4 pre-inserted nuts provided.
 The dimensions in the diagram are for Belt Specifications H (0.9mm thick).

Motor Specifications

Output (W)	Motor Specification		Reduction Ratio	Motor Length (A)
	Specification	Manufacturer		
6W	Constant Speed Motor	Panasonic	12.5-25	101.0
			30-180	108.0
		Oriental	12.5-18	105.0
			25-180	115.0
	Variable Speed Motor	Oriental	12.5-75	119.7
			90-180	125.7
		Taiwanese	12.5-18	115.0
			25-180	125.0
25W	Constant Speed Motor	Panasonic	12.5-180	131.9
			90-180	137.9
		Oriental	12.5-180	115.0
			25-180	127.5
	Variable Speed Motor	Oriental	12.5-75	129.0
			25-180	129.0
		Taiwanese	90-180	136.0
			12.5-18	127.0
Variable Speed Motor	Oriental	25-180	137.5	
		12.5-75	139.5	
	Taiwanese	90-180	146.5	
		12.5-18	146.5	

Conveying Capacity

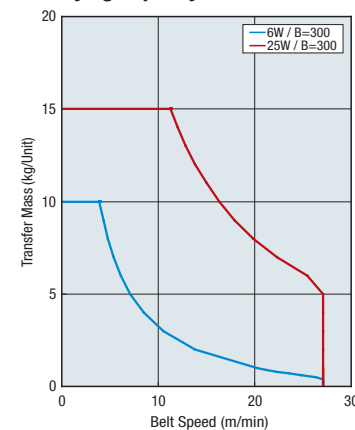

*Reference Value may differ by selected Belt.

Gearhead Reduction Ratio

*May decrease depending on load condition.

Gearhead Reduction Ratio	Belt Speed (m/min)	
	50Hz	60Hz
12.5	22.6	27.1
15	18.8	22.6
18	15.7	18.8
25	11.3	13.5
30	9.4	11.3
36	7.8	9.4
50	5.6	6.8
60	4.7	5.6
75	3.8	4.5
90	3.1	3.8
100	2.8	3.4
120	2.4	2.8
150	1.9	2.3
180	1.6	1.9

Flat Belt Conveyor Full Belt Type

End Drive, 2-Groove Frame (Pulley Dia. 30mm), continued

Conveyor Resource Site:
<http://www.misumiusa.com/conveyor/>
 Conveyor selection, Design your own kit,
 & Maintenance parts search.

Part Number	Width B 10mm Increment	Length L 5mm Increment	Motor				Belt Specification	FYA (Additional Counterbores) 5mm Increment	Motor Manufacturer Selection
			Output (W)	Voltage (V)	Specification	Gearhead Reduction Ratio			
CVSFA	60-300	280-2000	6	(Single-Phase) TA100 TA110 TA115 TA200 TA220 TA230	IM (Constant Speed Motor) SCM (Variable Speed Motor)	12.5 15 18 25 30 36 50 60 75 90	H (General Purpose, Green) W (General Purpose, White) G (For Sliding, Green) S (For Sliding, White) D (Static Conductive) F (Food Grade) O (Oil Resistant) N (Non-Stick Food Grade) J (No Belt)	190<FYA<L-210 * When not specified, there will be no additional counterbores.	A (Panasonic Motor) B (Oriental Motor) C (Taiwanese Motor) * SCM (Variable Speed Motor) is not selectable for A. R (No Motor, Gearhead)
			25						
			6 25	NV (No Motor)	NM (No Motor)	NH (No Gearhead)			

- Connect the motor so that the belt rotates in the direction of conveyance.
- When "No motor, gearhead" is selected, the motor mounting hole pitch will vary depending on the motor's power rating. Please see Technical Information in our Conveyor Selection web site for the dimension details.
- When "No motor, gearhead" is selected, this unit will be delivered unassembled. The customer is to assemble the unit according to the included assembly instructions. See our Conveyor Selection site for assembly procedures and packaging details.

Belt Specification	Standard Belt	Optional Belt 1	Optional Belt 2	No Belt
General Purpose	H (Green), W (White), HG (Green)	—	HY (Yellow Green), HBN (Sky Blue)	J (No Belt)
For Sliding	G (Green), S (White)	—	—	
For Inclined Transfer	LG (Green), LW (White)	—	—	
Grip Type	—	GG (Green), GW (White)	GSN (Green)	
Oil Resistant	O (Navy Blue), OH (Green), OG (Green)	OW (White)	ON (White)	
Non-Stick Food Grade	N (White), NS (White)	NB (Sky Blue), NBG (Lime Green) HH (Green), HW (White)	NWN (White), NSN (Sky Blue), NGN (Lime Green) HBG (Green), HBW (White), BW (White)	
Food Grade	F (White)	KW (White), KSB (Sky Blue), PHB (Sky Blue)	PHN (Sky Blue), PWN (Sky Blue), KWN (White)	
Static Conductive	D (Black), DS (Black)	—	DG (Black)	

If using Optional Belts, please select motor manufacturer A or B (Motor C is applicable for Standard Belt only).

Part Number	B	Available Types																		
		L280-300	L305-400	L405-500	L505-600	L605-700	L705-800	L805-900	L905-1000	L1005-1100	L1105-1200	L1205-1300	L1305-1400	L1405-1500	L1505-1600	L1605-1700	L1705-1800	L1805-1900	L1905-2000	
CVSFA	60-100	*	*	*	*	*	*	*	*	*	*	*	*	*	*	*	*	*	*	*
	110-150	*	*	*	*	*	*	*	*	*	*	*	*	*	*	*	*	*	*	*
	160-200	*	*	*	*	*	*	*	*	*	*	*	*	*	*	*	*	*	*	*
	210-250	*	*	*	*	*	*	*	*	*	*	*	*	*	*	*	*	*	*	*
	260-300	*	*	*	*	*	*	*	*	*	*	*	*	*	*	*	*	*	*	*

Part Number Example

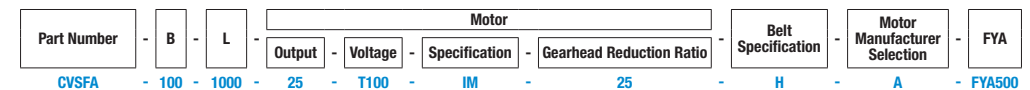

Part Number Alterations

- Motor Position Reversed
- Motor Cover with Window
- Brackets for Speed Controller Included
- Post-Assembly Insertion Nuts Included
- Motor with Terminal Box
- Stands (Legs)

For details of alterations, see P1276.