



# 90° Air Nozzle

## Standard / Compact

### Standard



Type	Material	Max. Operating Pressure	Breakdown Torque	Heat Resistance Temp.
AFTRW	ABS Resin Plastic	0.7MPa	7N·m	70°C

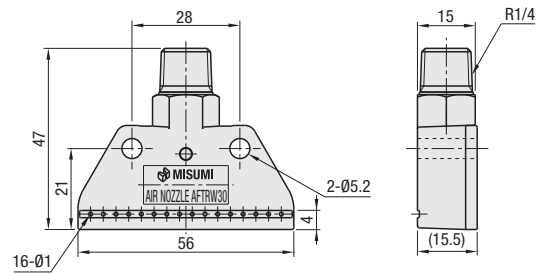

- Features**  
 Suitable for limited space. Easy to mount since air projection angle is vertical to the thread face.
- To prevent damage
    - Avoid excessive tightening of screw.
    - Avoid shocks to the screws.

Part Number	Air Flow Rate NL/min (for 0.3MPa)	Weight (g)	Unit Price	Volume Discount Rate		
Type	No.	Orifice	1-4 pc(s).	5-39	40-99	100-200
AFTRW	30	16-01	210	15		

For orders larger than indicated quantity, please use the Misumi website.

Part Number **AFTRW30** [Configure Online](#)

### Compact

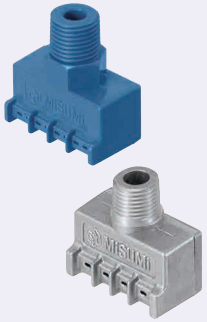

Type	Material	Surface Treatment	Max. Operating Pressure	Heat Resistance Temp.
AFTR	ABS Resin Plastic	-	0.7MPa	70°C
AFTRA	Aluminum Casting Alloy 383.0	Electroless Nickel Plating	0.7MPa	200°C

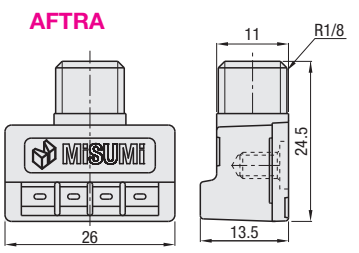
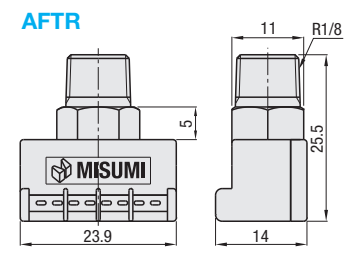

- Features**  
 Air Nozzles are more compact than Standard Type. (Width: Approx. 60%, Overall Length: Approx. 45% more compact)
- To prevent damage
    - Avoid excessive tightening of screws.
    - Avoid shocks to the screws.

Part Number	Orifice	Air Flow Rate NL/min (for 0.3MPa)	Weight (g)	AFTR			AFTRA					
				Unit Price	Volume Discount Rate	Unit Price	Volume Discount Rate					
Type	No.	8-00.6x1.5	210	4	1-4 pc(s).	5-39	40-99	100-200	1-4 pc(s).	5-9	10-19	20-30
AFTR	15	8-00.6x1.5	210	4	-	-	-	-	-	-	-	-
AFTRA	15	4-00.8x1.8	190	10	-	-	-	-	-	-	-	-

For orders larger than indicated quantity, please check with WOS.

Part Number **AFTR15** [Configure Online](#)

### Air Flow Rate Property Table

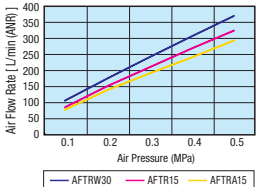

### Quietness Property Table

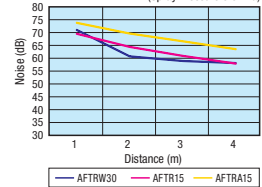

### Velocity Property Table

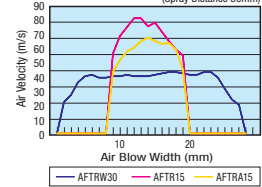

### Air Colliding Force Property Table

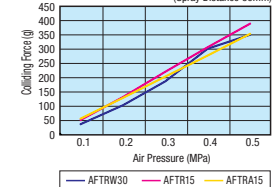

Values on the graph are for reference, not guaranteed.

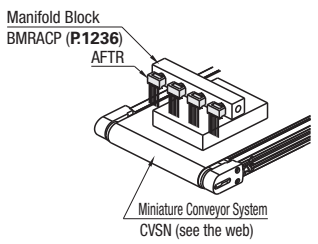
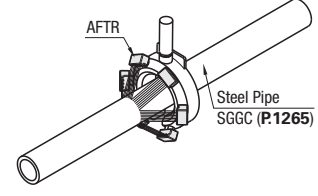
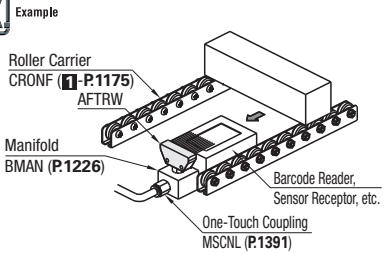

(Surface Cleaning)

(Dry)



# 90° Air Nozzle

## Wide / Vertical Blow

### Wide Type



Type	Material	Max. Operating Pressure	Heat Resistance Temp.
AFTRSW	ABS Resin Plastic	0.7MPa	70°C

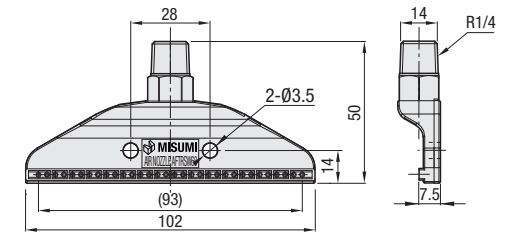

- Features**  
 Blow Port width approx. two times as wide as Standard Type (AFTRW), allows for parts reduction. Ribs are provided to protect the orifice.
- To prevent damage
    - Avoid excessive tightening of screws.
    - Avoid shocks to the screws.

Part Number	Orifice	Air Flow Rate NL/Min (for 0.3MPa)	Weight (g)	Unit Price	Volume Discount Rate		
Type	No.	32-01	290	20	5-39	40-99	100-200
AFTRSW	60	32-01	290	20			

For orders larger than indicated quantity, please check with WOS.

### Vertica Blow Type



Type	Material	Max. Operating Pressure	Heat Resistance Temp.
AFTRV	ABS Resin Plastic	0.7MPa	70°C

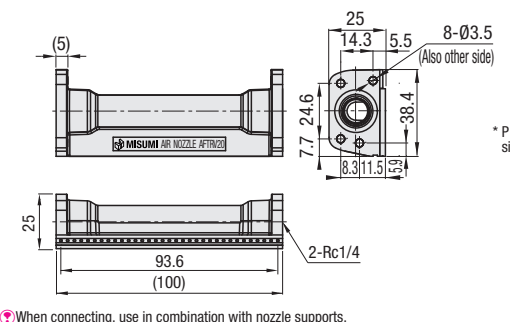

- Features**  
 Connection mechanism enables spray width to be adjusted according to the workpiece.

\*Connect nozzles by tightening screws with O-Rings (JIS Nominal Number P14) in between.

\*Plug one side when using a single nozzle.

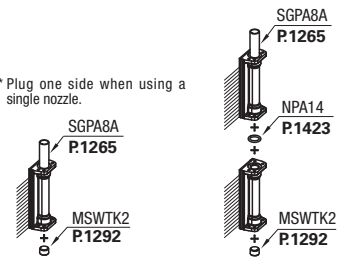

When connecting, use in combination with nozzle supports.

Part Number	Orifice	Air Flow Rate NL/Min (for 0.3MPa)	Weight (g)	Unit Price	Volume Discount Rate		
Type	No.	33-01	290	25	5-39	40-99	100-200
AFTRV	20	33-01	290	25			

For orders larger than indicated quantity, please check with WOS.

Ordering Example **Part Number** **AFTRSW60** **AFTRV20**

Days to Ship [Configure Online](#)

### Air Flow Rate Property Table

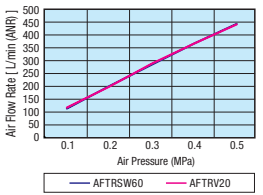

### Quietness Property Table

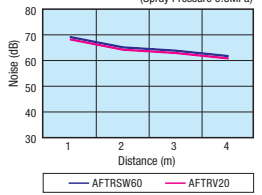

### Velocity Property Table

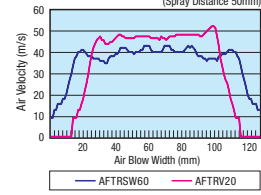

### Air Colliding Force Property Table

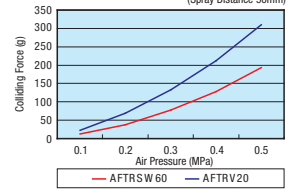

Values on the graph are for reference, not guaranteed.

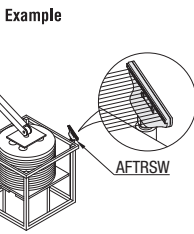

(Separating thin sheet metal plates coated with machining oil) · Prevents duplicative conveyance of the subject workpiece.

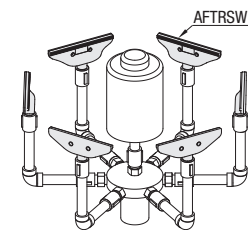

(Cleaning of Workpiece Exterior) · Suitable for surface cleaning of cylindrical workpiece.

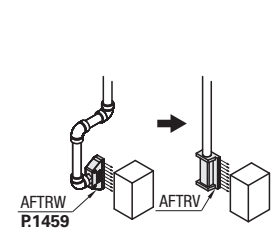

(Plumbing Reduction) · Easy handling of plumbing.

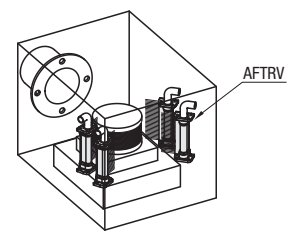

(Drying in Air Blow Room) · Effective for air blow in limited spaces as nozzle and plumbing are arranged in the same direction.