

Shock Absorption Stoppers

Bolts / Hex Socket Head Cap Screws with Low Elastic Rubber Head

Bolts with Low Elastic Rubber Head

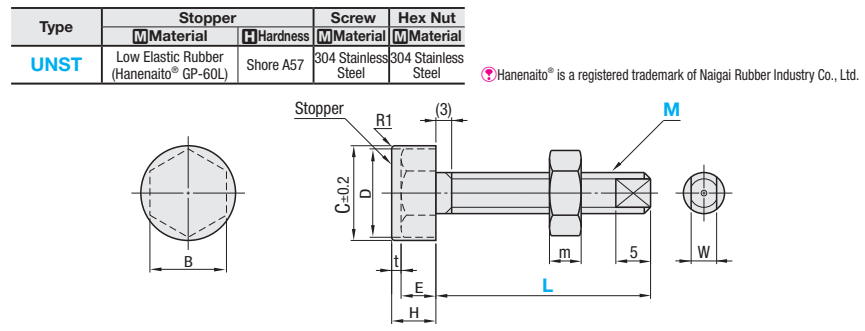

Hanenaito® is a registered trademark of Naigai Rubber Industry Co., Ltd.

Part Number Type	M (Coarse)	L	t	C	D	B	H	E	Shock Absorption Amount (kgf-cm)	Withstand Load (kgf)	m	W	Unit Price
UNST	3	10 15 20	4	8	6.15	5.5	6	2	0.045	2.2	1.8	2	
	4	10 15 20 30	4.2	10	7.7	7	7	2.8	0.069	3.4	2.4	3	
	5	20 30 40	4.5	12	8.8	8	8	3.5	0.112	5.4	3.2	4	
	6	20 30 40	5	15	11.1	10	9	4	0.207	9.4	3.6	4.5	
	8	30 40 50	5.7	18	14.4	13	11	5.3	0.350	14.2	5	6.5	
	10	30 40 50	5.6	21	17.8	16	12	6.4	0.517	23.4	6	8	

Hex Socket Head Cap Screws with Low Elastic Rubber Head

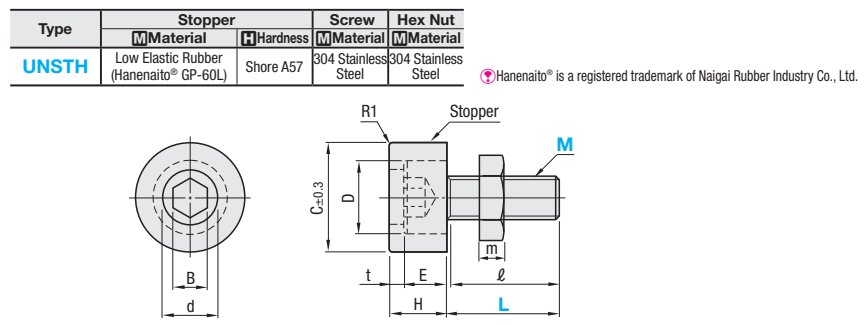

Hanenaito® is a registered trademark of Naigai Rubber Industry Co., Ltd.

Part Number Type	M (Coarse)	L	t	C	D	d	B	H	E	Shock Absorption Amount (kgf-cm)	Withstand Load (kgf)	m	l	Unit Price
UNSTH	4	10 15 20 *30	4.2	11	7	5	3	8.2	4	0.055	2.4	3.2	Full Thread(22)	
	5	15 20	4.5	13	8.5	7	4	9.5	5	0.072	3.0	4	Full Thread	
	6	15 20 25 30 *40	5	18	10	8	5	11	6	0.197	7.4	5	Full Thread(26)	
	8	25 30	5.7	20	13	9	6	13.7	8	0.272	8.8	6.5	Full Thread	
	10	30 40 *50	5.6	25	16	12	8	15.6	10	0.444	14.4	8	Full Thread(34)	

*l dimension for *marked L dimension is in ().

Part Number	-	L
UNST8	-	40
UNSTH4	-	20



Configure Online



Configure Online

Material with Excellent Shock Absorption

Low Elastic Rubber
It is used as a cushioning material for pallet damper, conveyor machine, precision instrument etc, because of its good elongation and shock absorption. Also it is used as vibration absorption materials for various precision instruments because of its excellent vibration absorption.

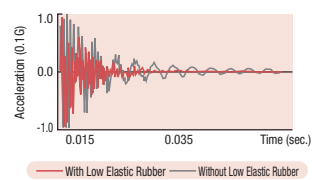

Impact Resilience Variation by Temperature of Low Elastic Rubber

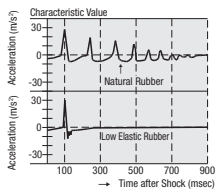
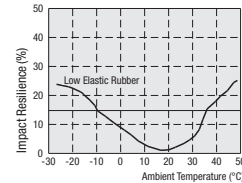

Properties

Item	Unit	Low Elastic Rubber
Hardness	(JIS-A)	57
Tensile Strength	(MPa)	8.3
(Same as above)	(kgf/cm²)	85
Elongation	(%)	810
Impact Resilience	(%)	2
Compression Set	70°Cx22hr (%)	16
Specific Gravity		1.35

*Above data are standard values, not guaranteed values.

Drop Comparison of Rubber Ball and Low Elastic Rubber Ball

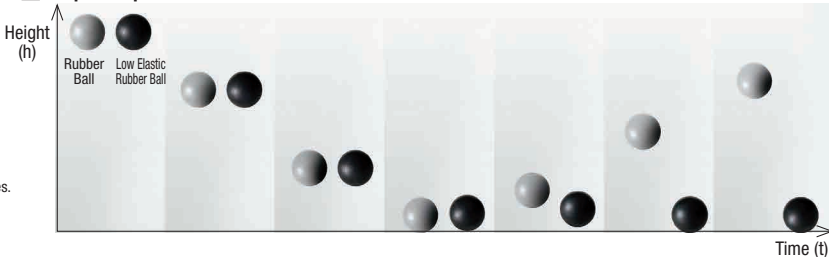

Washers, Stoppers with Plates

Urethane Type / Low Elastic Rubber Type

Urethane Type Urethane Stoppers with Washers



Urethane is baked on a 304 Stainless Steel plate.

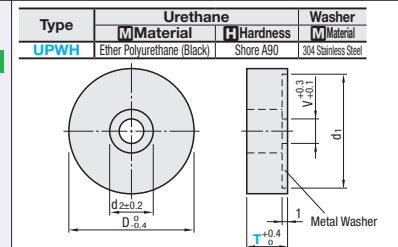

Urethane Type Urethane Stoppers with Washers for Extra Low Head Screws



Urethane is baked on a 304 Stainless Steel plate.

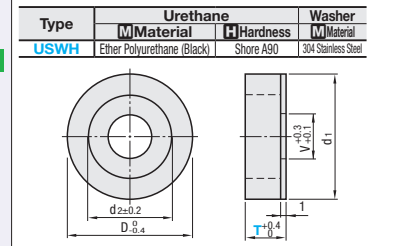

Urethane Type Urethane Stoppers with Plates



Urethane is baked on a 304 Stainless Steel plate.
*Use low head bolts.

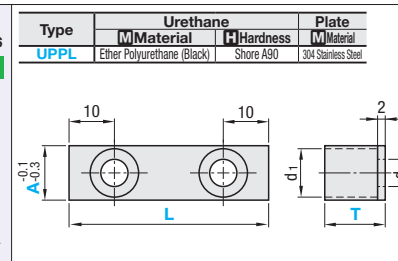

Part Number	-	T	-	L
UPWH4	-	8	-	
USWH3	-	7	-	
UPPL12	-	6	-	30

Days to Ship [Configure Online](#)

Part Number Type	No.	T	D	d1	d2	V	Unit Price
UPWH	3	7	15	14	6	3	
	4	8	20	19	8	4	
	5	9	25	24	9.5	5	
	6	10	30	29	11	6	
	8	12	40	39	14	8	
	10	14	50	49	17	10	

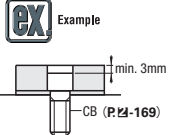

Part Number Type	No.	T	D	d1	d2	V	Unit Price
USWH	3	4	11	10	7	3.5	
	4	4	13	12	9	4.5	
	5	4	14	13	10	6	
	6	4	15	14	11	7	

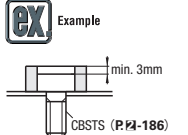

Part Number Type	A	T	L	d	d1	Unit Price
UPPL	12	6	30	3.5	6.5	
	15	8	50			
	19	10	50	4.5	8.0	
			75			

Price [Configure Online](#)

Low Elastic Rubber Low Elastic Rubber Stoppers with Washers



Rubber is baked on a 304 Stainless Steel plate.

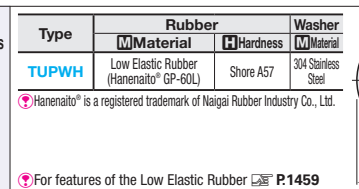

Part Number Type	No.	T	D	d1	d2	V	Shock Absorption Amount (kgf-cm)	Withstand Load (kgf)	Unit Price	
										Type
TUPWH	3	7	15	14	6	3	0.112	4.2		
	4	8	20	19	8	4	0.161	3.6		
	5	9	25	24	9.5	5	0.261	8.0		
	6	10	30	29	11	6	0.474	6.8		
	8	12	40	39	14	8	0.523	14.0		
								0.919	21.4	
								2.018	16.4	
								2.221	41.6	

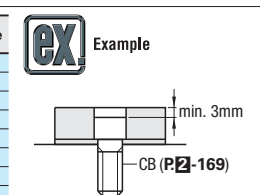

Low Elastic Rubber Low Elastic Rubber Stoppers with Plates



Rubber is baked on a 304 Stainless Steel plate.

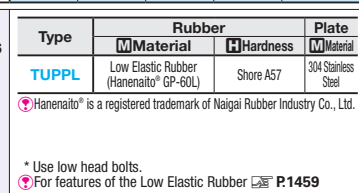

Part Number Type	A	T	L	d	d1	Shock Absorption Amount (kgf-cm)	Withstand Load (kgf)	Unit Price
TUPPL	12	6	30	3.5	6.5	0.217	6.6	
			50			0.577	17.6	
			30			0.324	6.0	
	15	10	50	3.5	6.5	0.786	14.6	
			30			0.408	7.4	
			50			1.024	19.0	
19	10	50	4.5	8.0	1.234	23.0		
		75			2.51	47.0		

Part Number	-	T	-	L
TUPWH6	-	10	-	
TUPPL12	-	6	-	30

Days to Ship [Configure Online](#)

Price [Configure Online](#)